

AUTOMATION SWING GATE OPENER

Installation Manual



SPARK 4 - SPARK 6

Automation Swing Gate Opener

Index

Intended use and restrictions	P.4
Intended use	P.4
Restrictions	P.4
Packing list	P.4
Description	P.5
Technical features	P.5
Dimensions	P.5
Description of parts	P.6
Installation	P.6
Preliminary checks	P.6
Tools and materials	P.7
Standard installation	P.7
Installing the operator	P.8
Wiring the operator	P.11
Motor wiring operations	P.11
Limit switches	P.12
Testing the Automated System	P.13
Manually releasing the operation	P.13
Safety instructions	P.13
Important safety instructions	P.13
Maintenance	P.14
Periodic maintenance	P.14
Trouble shooting	P.14
Extra-ordinary maintenance	P.15
Phasing out and disposal	P.16



WARNING!

Important instructions for the safety of people:

READ CAREFULLY!



- 1) ATTENTION! To ensure the safety of people. It is important that you read all the following instructions. Incorrect installation or incorrect use of the product could cause serious harm to people.
- 2) Carefully read the instructions before beginning to install the product.
- 3) Do not leave packing materials (plastic, polystyrene, etc.) within reach of children as such materials are potential sources of danger.
- 4) Store these instructions for future reference.
- 5) This product was designed and built strictly for the use indicated in this documentation. Any other use, not expressly indicated here, could compromise the good condition/operation of the product and/or be a source of danger.
- 6) Carin declines all liability caused by improper use or use other than that for which the automation swing gate opener was intended.
- 7) Do not install the equipment in an explosive atmosphere; the presence of inflammable gas or fumes is a serious danger to safety.
- 8) The mechanical parts must conform to the provisions of standards En 12604 and En 12605.
- 9) Carin is not responsible for failure to observe Good Technique in the construction of the closing elements to be motorised, or for any deformation that may occur during use.
- 10) The installation must conform to standards En 12453 and EN 12445. The safety level of the automated system must be C+D.
- 11) Before attempting any job on the system, cut out electrical power.
- 12) The mains power supply of the automated system must be flitted with an all-pole switch with contact opening distance of 3mm or greater. Use of a 6A thermal breaker with all-pole circuit break is recommended.
- 13) Make sure that the earthing system is perfectly constructed, and connect metal parts of the means of the closure to it.
- 14) The safety device (En 12978 standard) protects any danger areas against mechanical movement risks, such as crushing, dragging, and shearing.
- 15) Use of at least one indicator-light is recommended for every system, as well as a warning sign adequately secured to the frame structure, in addition to the devices mentioned at point 14.
- 16) Carin declines all liability as concerns safety and efficient operation of the automated system, if system components not produced by Carin are used.
- 17) For maintenance, strictly use original parts by Carin.
- 18) Do not in any way modify the components of the automated system.
- 19) The installer shall supply all information concerning manual operation of the system in case of an emergency, and shall hand over to the user the warnings handbook supplied with the product.
- 20) Do not allow children or adults to stay near the product while it is operating.
- 21) Keep remote controls or other pulse generators away from children, to prevent the automated system from being activated involuntarily.
- 22) Transit through the leaves is allowed only when the gate is fully open.
- 23) The user must not attempt any kind of repair or direct action whatever and contact qualified personnel only.
- 24) Anything not expressly specified in these instructions is not permitted.

Intended use and restrictions

Intended use

Spark gearmotor is designed to automate residential and apartment block swing gates in even intensive use conditions. There are four models available Spark 4 DC ordinary model, Spark 4 AC ordinary model Spark 6 DC extra long model Spark 4 AC extra long model.

Restrictions

	Spark 4	Spark 6
Gate-leaf width(m)	3.5	5
Gate-leaf weight(kg)	500	500

Packing list

When you receive your Compact Operator, you should do as follow. Inspect the shipping box for physical damage such as a torn carton. Then inspect the operator after you remove it from the box. Notify the carrier immediately if you note any damage because the carrier must witness the damage before you can file a claim. As you unpack the box, insure that all the parts listed below are included. Your kit (a pair of operators) has these parts:

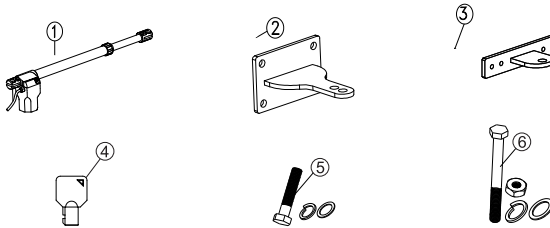

No.	Description	Quant
1	Motors	2
2	Rear bracket	2
3	Front bracket	2
4	Key	2
5	Short screw	8
6	Long screw	8

Description

The automated system for swing gates comprises an electromechanical operator which drives the gate leaves by means of a worm screw. The operator are equipped with opening and closing limit switches. The Carin operator is irreversible and locks mechanically when the motor is not in use, therefore a lock does not need to be fitted.

Technical features

	Spark 4	Spark 6
Power supply	230VAC/50Hz	
Electric motor	230V	230V
Absorbed power	320W	320W
Current	1,5A	1.5A
Motor speed	1800RPM	1800RPM
Thrust	2800N	2800N
Travel	400mm	600mm
Protection Class	Ip45	
Temperature	-20°C~50°C	

Dimensions

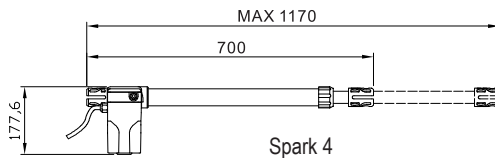

Spark 4

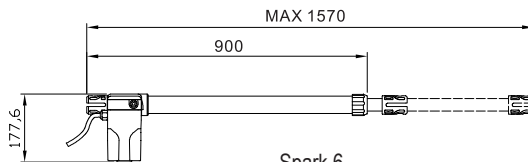

Spark 6

Description of parts

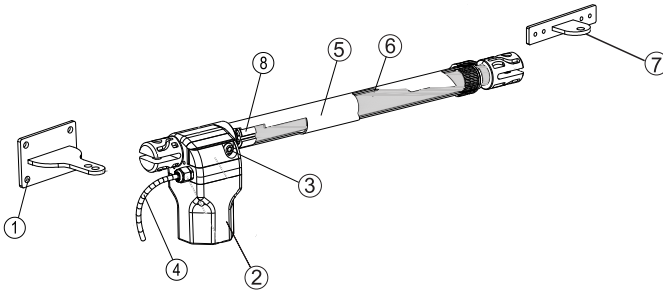

- | | |
|-----------------------------|-------------------------------|
| 1) Rear bracket | 2) Main body of the gearmotor |
| 3) Emergency release device | 4) Power cable |
| 5) Arm outside | 6) Arm inside |
| 7) Front bracket | 8) Copper nut |

Installation

⚠ Installation must be carried out by expert qualified personnel and in full compliance with current regulations.

Preliminary checks

⚠ To ensure a correct operation of the automated system, make sure the following requirements are observed as for the gate structure (existing or to be realized):

- The leaf must be fixed firmly on the hinges to the pillars and must not be flexible during the movement
- Before the installation, verify all dimensions etc.
- The mechanical parts must conform to the provision of standards En12604 and En12605.
- Leaf length in compliance with the operator specification.
- Sturdy and stiff structure of the leaves, suitable for automation
- Regular and uniform movement of the leaves, without any friction and dragging during their entire opening.
- Presence of an efficient earthing for electrical connection of the operator.
- Make sure there are closing mechanical stops.

⚠ The condition of the gate structure directly affects the reliability and safety of the automated system.

Tools and materials

Make sure you have all the tools and materials you will need for the installation at hand to work in total safety and compliance with the current standards and regulation. The figure shows some examples of installer's tools.

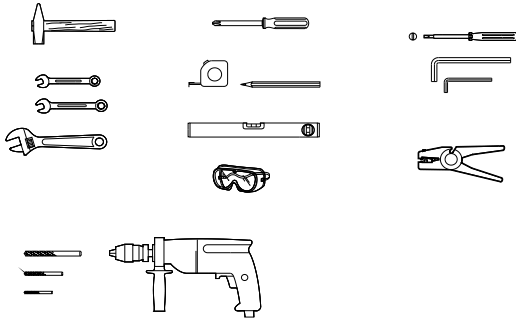

Standard installation

- | | |
|----------------|-----------------------------|
| 1) Operators | 2) Receiver |
| 3) Logic board | 4) Key-operated push-button |
| 5) Photocells | 6) Flashing lamp |
| 7) Transmitter | 8) Mechanical stop |

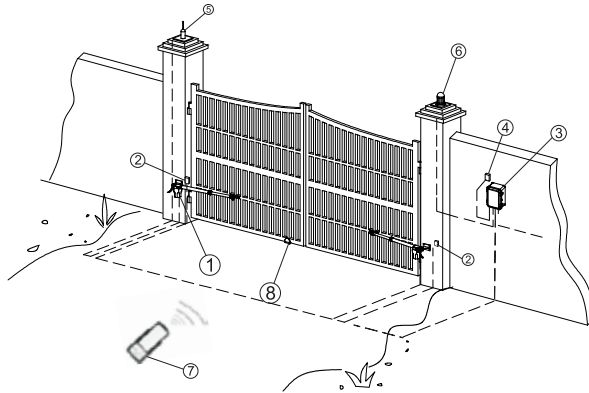

Installing the operator

▲ The following illustrations are only examples, given that the space for securing the automation and accessories varies depending on the overall dimensions.

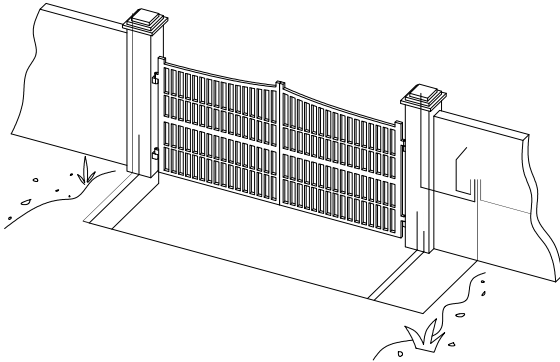

NOTE:

Use suitable tubes and/or hoses to lay electric cable;

To avoid any kind of interference always separate low-voltage accessories and control cables from 230V power supply cable using separate tubes

1) Before you install the Operator, you need to prepare the gate itself for the operator. Be sure to do the following three things:

1. Make sure that the gate structure is solidly built.
2. Make sure that the gate moves smoothly on its hinges without excessive friction by swinging it opened and closed by hand. Lubricate all the gate's moving parts.
3. Provide positive stops for the gate leaves in the opened and closed positions.

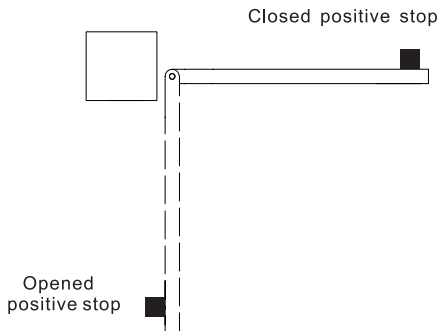

Provide positive stops for the gate leaf

- 1) Determine the fitting position of the operator with reference to the form. Check with care if the distance between the open leaf and any obstacles (wall, fence ect) is higher than the operator.

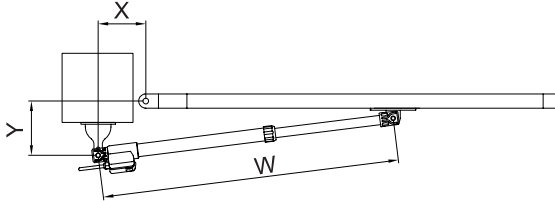

NOTE:

- 1) Keep a dimension in such a way that the operator dose not strick the pillar.
- 2) check with care if the distance between the open leaf and any obstacles (wall, fence, etc.) is higher than the operator

Spark 4

PATHENGINE

	W	X	Y	Z
90°	1110	150	200	400
90°	1110	200	150	400
95°	1110	200	150	400
100°	1110	200	200	400

Spark 6

PATHENGINE

	W	X	Y	Z
90°	1510	150	200	600
90°	1510	200	150	600
95°	1510	200	150	600
100°	1510	200	200	600

- 2) Trace all axis and dimensions, the secure the gearmotor anchoring bracket to the wall or post as well as the arm-to-gate anchoring bracket,

Note: the illustrations are mere examples, it is up to the installer to choose the most suitable solution depending on gate-leaf type and thickness.

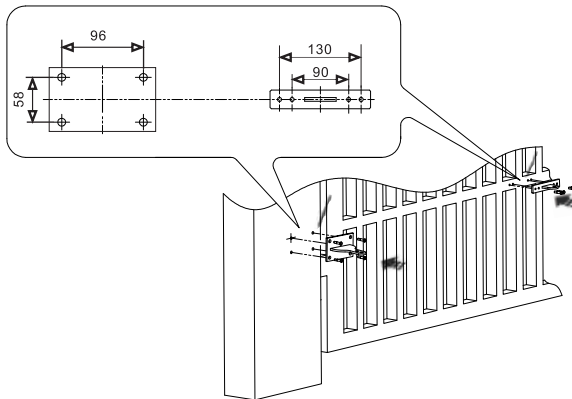

- 3) Fix the rear bracket the front bracket in the position determined before, use suitable accessories to fix the motor to the wall using the provided screws. During the fastening operations, check if the bracket is perfectly horizon by means of a level.
- 4) Assemble the rear brack fitting to the operator as shown in following picture.

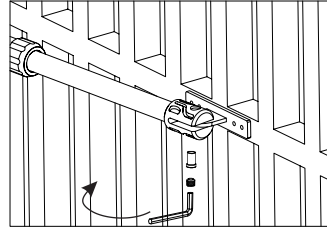
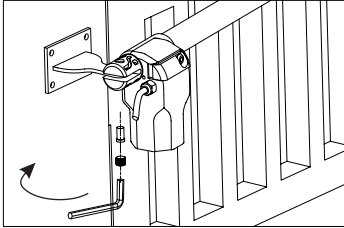

ATTENTION:

If the rear bracket in the position determined before. If the pillar is in iron, carefully weld the bracket directly to the pillar .If the pillar in masonry, use suitable accessories to fix the motor to the wall using the provided screws. During the fastening operations, check if the bracket is perfectly horizontal using a level.

- 5) Check if the front bracket fitting is in the correct position. If it is not in the correct position, you should release the operator . Do as the following pictures. Then Regulation of the dimension of W.
- ATTENTION:**

The operator can be moved by hand only if it is installed on the gate and in released position :

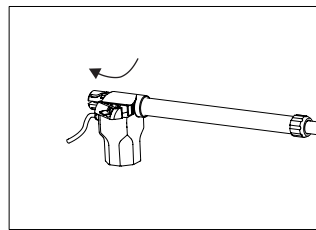
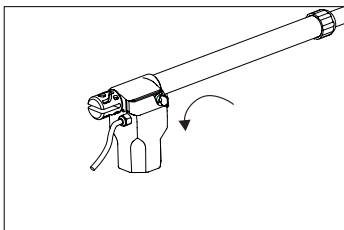

ENGLISH

The Manual Release mechanism is a built-in release device of the operator .Insert the key and turn it a half turn in the direction of the gates closing to disengage the operators motorized operation. You can now move the gate leaf by hand to open or close the gate. Operating the gate leaf by hand is necessary during installation and is useful during power failures

Periodic maintenance

Periodic maintenance to be carried out by the end-user is as follows: wipe clean the glass surface of the photocells ; check that the safety devices work properly; remove any obstructions. We suggest checking the state of lubrication and tightness of the anchoring screws on the operator. To check the efficiency of the safety devices, move an object in front of the photocells when gate is closing. If the operator inverts the motion or stops, the photocells are working properly. This is the only maintenance procedure to be carried out with the power source connected. Before performing any maintenance procedures, cut off the main power, to prevent possible accidents due to gate movement. To clean the photocells use a water dampened cloth. Do not use solvents or other chemical products which may ruin the devices. In the event of any strange vibrations or squeaking, lubricate the joints with grease.

Note: Make sure there are no plants within the photocell's beam, and that the gate motion is free of any obstacles.

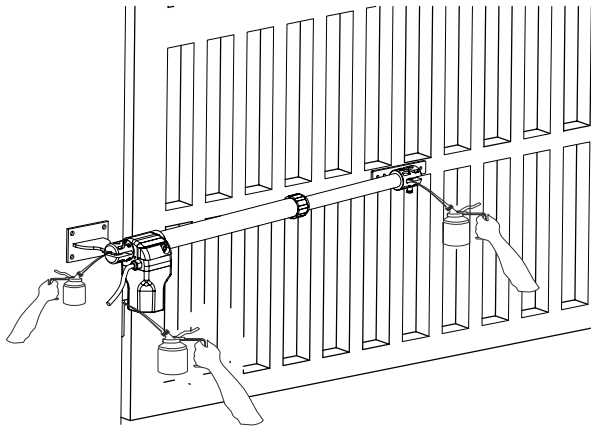



AUTOMATION SWING GATE OPENER

Installation Manual



www.seco.gr

Agiou Dimitriou 263, TK. 17342, Athens, Greece

Tel. 0030 210 9846222

Fax 0030 210 9822276

